

Manuale Operativo Cocktail Bar 05

05

Indice	pag.	02
Perché	pag.	03
Genesi Logo	pag.	04
Font	pag.	05
Colori	pag.	06
Bianco e Nero	pag.	07
Alternative Colori	pag.	08
Area di Rispetto	pag.	09
Riduzione	pag.	10
Da non Fare	pag.	11
Business Set	pag.	12
Gadget	pag.	15

Dal punto di vista strettamente operativo l'immagine coordinata è impostata sul marchio e sul logotipo dell'Azienda e si sviluppa e si declina su tutte le applicazioni funzionali, dallo stampato per corrispondenza, al biglietto da visita fino ai mezzi di trasporto, alla pubblicità e agli oggetti promozionali.

Manuale di corporate identity

Per una corretta gestione dell'immagine coordinata una volta definiti gli elementi basilari (marchio, logotipo, lettering, colori, etc.) è necessaria l'adozione di un manuale d'uso operativo. Il manuale di corporate identity costituisce la base del sistema di identificazione visiva di un'Azienda (visual identity) e codifica ogni elemento di comunicazione sulla base di parametri applicativi chiari, coerenti, flessibili e naturalmente riconoscibili.

A cosa serve

L'utilizzo del manuale consente a ogni Ufficio operativo centrale o periferico di fornire indicazioni chiare e precise sul corretto utilizzo del marchio in ogni ambito d'uso operativo e funzionale. Questo consente di evitare errori nella stampa e realizzazione di tutti i materiali, risparmi con i fornitori, assicurando all'Azienda un'immagine di affidabilità e serietà.

Genesi logo

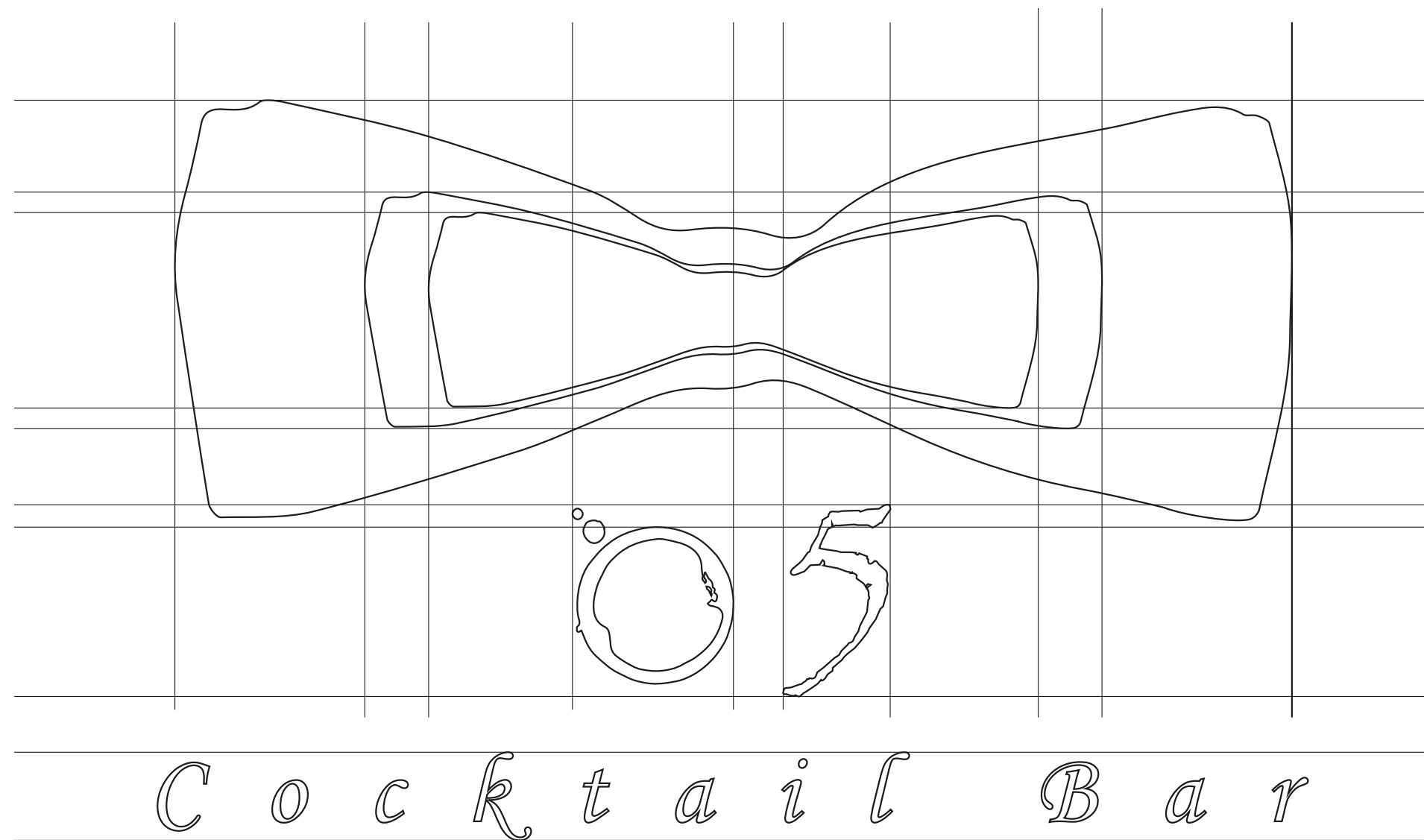

Font

Monotype Corsiva Regular

ABCDEFGHIJKLMNOPQRSTUVWXYZ

abcdefghijklmnopqrstuvwxyz

1234567890

!"£\$%&/'()=?i^*°§:;,.,

Papyrus Regular

ABCDEFGHIJKLMNOPQRSTUVWXYZ

abcdefghijklmnopqrstuvwxyz

1234567890

!"£\$%&/'()=?i^*°§:;,.,

Colori

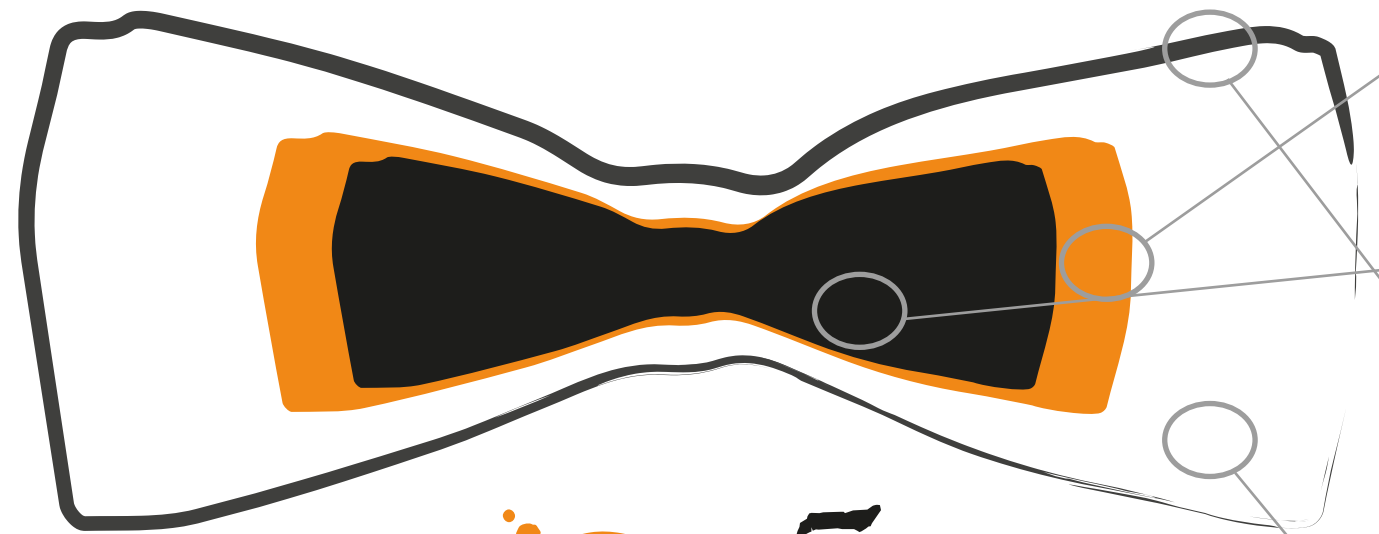

Cocktail Bar



C:0 - M:55 - Y:100 - K:0
R:204 - G:128 - B:41
HEX: # CC8029

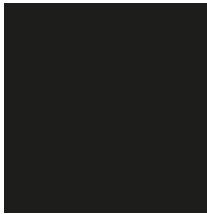

C:0 - M:0 - Y:0 - K:100
R:0 - G:0 - B:0
HEX: # 000000



C:0 - M:0 - Y:0 - K:82
R:82 - G:82 - B:82
HEX: # 525252



C:0 - M:0 - Y:0 - K:0
R:255 - G:255 - B:255
HEX: # ffffff

Bianco e Nero



BIANCO
NERO



BIANCO
NERO



BIANCO
NERO
GRIGIO K: 40

Alternative Colori



C:0 - M:55 - Y:100 - K:0
R:204 - G:128 - B:41
HEX: # CC8029

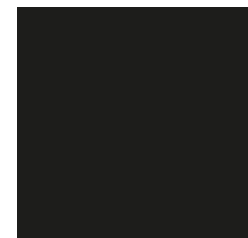

C:0 - M:0 - Y:0 - K:100
R:0 - G:0 - B:0
HEX: # 000000

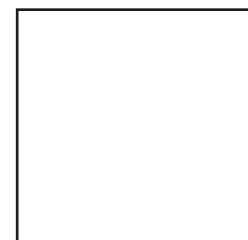

C:0 - M:0 - Y:0 - K:0
R:255 - G:255 - B:255
HEX: # ffffff

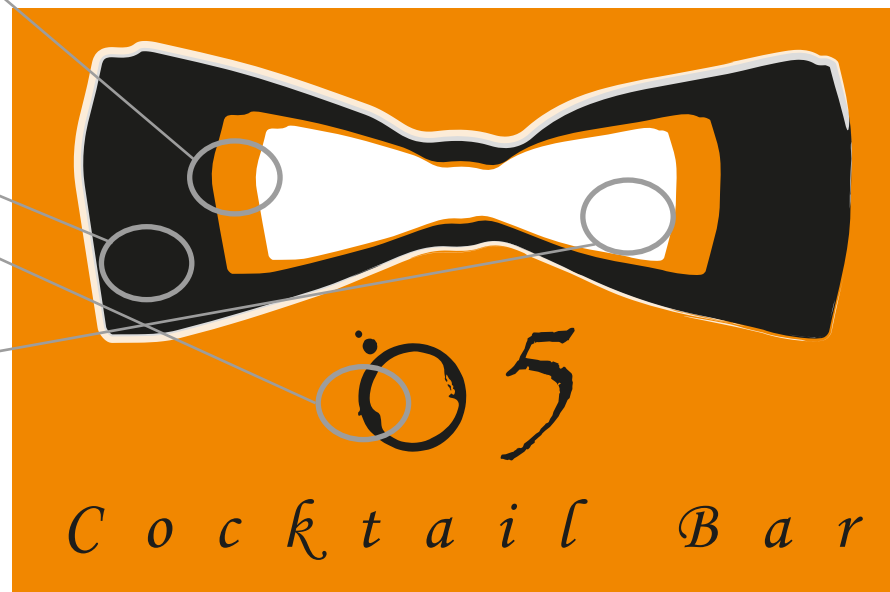

Area di Rispetto



Riduzione



05

100%

Cocktail Bar



05

70%

Cocktail Bar



05

50%

Riduzione massima

Cocktail Bar



05

Cocktail Bar

Ruotare



05

Cocktail Bar

Distorcere Dimensioni

Da non Fare

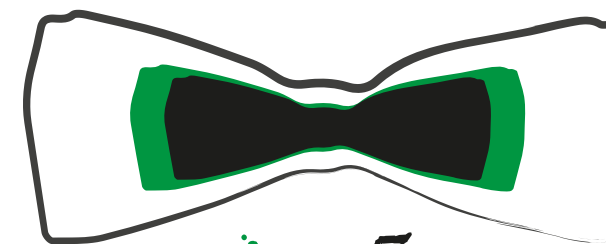

05

Cocktail Bar

Cambiare Colore



05

Cocktail Bar

Cambiare Font

Business Set

Biglietto da Visita



Business Set

Busta



Business Set

42 mm
↑
↓



14

Carta Intestata

Formato: A4

↑
30,5 mm
↓

Gadget



Tovagliolo

240 x 240 mm



15

Gadget



Papillon Cameriere

